

# Pin headers pitch 2mm

Pin headers, single and double row, with straight or angled pins, pitch 2.00 mm, all items shown on this page can be cut to size

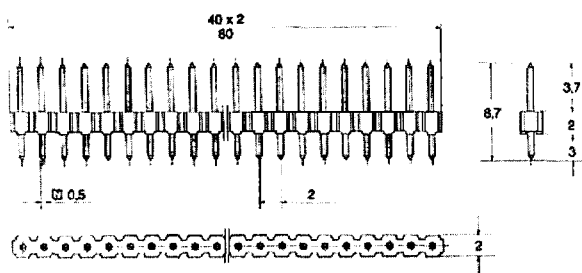

Part no.	No. of contacts
AW 200/G <sup>1</sup> 40	40
AW 200/Z <sup>2</sup> 40	40

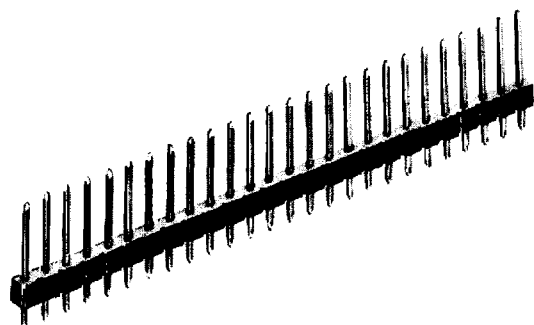
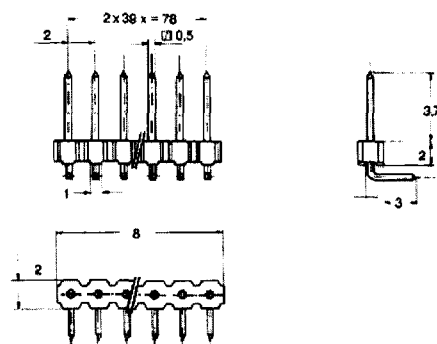
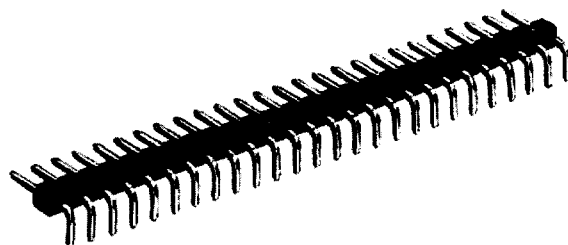

Part no.	No. of contacts
AW 200 A/G <sup>1</sup> 40	40
AW 200 A/Z <sup>2</sup> 40	40

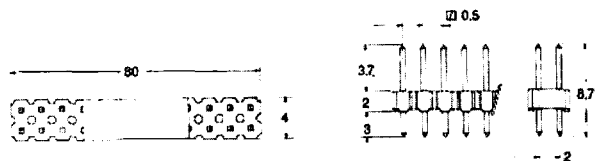
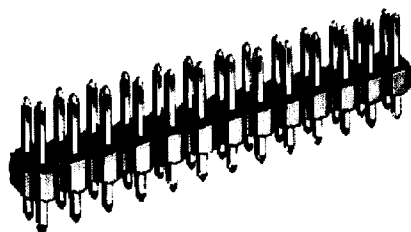

Part no.	No. of contacts
AWL 200/G <sup>1</sup> 80	80
AWL 200/Z <sup>2</sup> 80	80

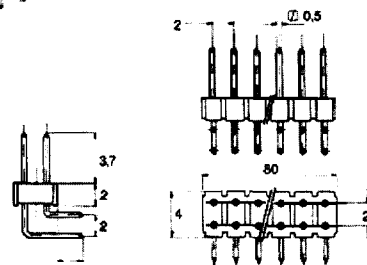
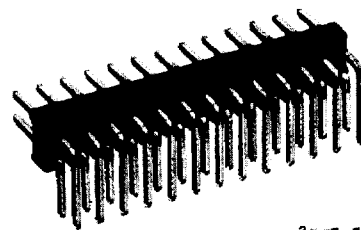

Part no.	No. of contacts
AWLA 200/G <sup>1</sup> 80	80
AWLA 200/Z <sup>2</sup> 80	80

### Technical data

- |   |  |
|---|--|
| <p>1. Materials</p> <p>Insulation<br/>body: PBT, GF, UL 94-VO</p> <p>Contact:<br/>CuZn<br/>G<sup>1</sup> = gold plated over nickel<br/>Z<sup>2</sup> = tin plated over nickel</p> | <p>2. Mechanical data</p> <p>Pitch: 2 mm</p> <p>3. Electrical data</p> <p>Nominal power: 1 A<br/>Nominal voltage: 150 V/AC<br/>Insulation resistance: &gt; 10 MΩ</p> |
|---|--|